



PRINCE WILLIAM COUNTY

Prince William County, Virginia Internal Audit Report – Cash Handling

June 3, 2020



TABLE OF CONTENTS

Transmittal Letter	1
Executive Summary	2
Background	4
Financial Analysis	6
Objectives and Approach	11
Observations Matrix	13
Process Improvement Opportunities	18
Process Maps	19

TRANSMITTAL LETTER



June 3, 2020

The Board Audit Committee of
Prince William County, Virginia
1 County Complex Court
Prince William, Virginia 22192

RSM US LLP
1861 International Drive
Suite 400
McLean, VA 22102
O: 321.751.6200 F: 321.751.1385
www.rsmus.com

Pursuant to the internal audit plan for calendar year ending (“CY”) 2019 for Prince William County, Virginia (“County” / “PWC”), approved by the Board of County Supervisors (“BOCS”), we hereby present the internal audit of the cash handling process. We will be presenting this report to the Board Audit Committee of Prince William County at the next scheduled meeting on July 21, 2020.

Our report is organized into the following sections:

Executive Summary	This provides a high-level overview and summary of the observations noted in this internal audit, as well as the respective risk ratings.
Background	This provides an overview of the process as well as relevant background information.
Objectives and Approach	The objectives of this internal audit are expanded upon in this section, as well as the various phases of our approach.
Observations Matrix	This section gives a description of the observations noted during this internal audit and recommended actions, as well as Management’s response including the responsible party, and estimated completion date.
Process Maps	This section illustrates process maps related to the process reviewed.

We would like to thank the staff and all those involved in assisting our firm with this internal audit.

Respectfully Submitted,

RSM US LLP

Internal Auditors



EXECUTIVE SUMMARY

Background

Prince William County collects, accounts for and manages public funds, such as cash and cash equivalents. Overseen by the County's Finance Department, the cash handling and cash management process encompasses the authority, recordkeeping, custody and reconciliation of cash transactions. The *Cash Handling and Cash Management Policy and Procedures*, issued by the Finance Department, provides guidelines for cash handling processes across County departments/agencies.

The County recently transitioned its banking services to Wells Fargo which enabled new bank services and functionality for departments/agencies to utilize. Major banking services and functions now available include: LockBox enabled online imaging capabilities, bill payer consolidations, among many minor functionality improvements. To facilitate applicable operations, the County utilizes Wells Fargo's customer online portal, Commercial Electronic Office (CEO). Additionally, the County has contracted with Brinks for armored transport services at County cash collection points.

The County's Department of Parks, Recreation and Tourism ("DPRT"), collected ~\$9.8M* from July 1, 2018 through June 30, 2019 ("FY2019"). Specifically, SplashDown Waterpark collected ~\$1.6M*, or 16% of DPRT collections, during FY2019. SplashDown Waterpark has the highest volume of transactions during a compressed time period. DPRT utilizes Brinks for their deposit process.

The Finance Department's Tax Administration Division (renamed "Taxpayer Services Division" in FY20) collected ~\$922M* during FY2019. Specifically, ~80M* was collected by mail at the three Tax Administration Division locations during FY2019. ~\$185M* was also collected by mail at the County's bank operated processing site (LockBox). Therefore, ~29% of applicable tax collections were collected via mail. Tax Administration also utilizes Brinks for their deposit process.

While our scope related to Tax Administration was limited to checks received by mail, we gained a cursory understanding of the complexities of the Division's operations. Based on our understanding, various teams and individuals are responsible for a myriad of tax types which do not all follow the same collection process. Coupled with recent managerial changes and the fact that the Division is responsible for the majority of the County's revenue; we are recommending an Internal Audit be completed of the entire cash handling process related to all tax types due to the Division's inherent high-risk.

Overall Summary / Highlights

The observations identified during our assessment are detailed within the pages that follow. We have assigned relative risk or value factors to each observation identified. Risk ratings are the evaluation of the severity of the concern and the potential impact on the operations of each item. There are many areas of risk to consider in determining the relative risk rating of an observation, including financial, operational, and/or compliance, as well as public perception or 'brand' risk.

Objectives and Scope

The primary objective of this internal audit was to evaluate the effectiveness and adequacy of key processes and control functions for cash handling within specific departments/agencies, and assess compliance with applicable County policies and procedures. Specific procedures included:

- Assessed the adequacy of the applicable policies, procedures and guidelines;
- Reviewed forms utilized and assessed the adequacy of document retention procedures related to cash collections, deposits, and reconciliations;
- Identified the process for safeguarding and monitoring of assets;
- Identified and assessed the effectiveness of segregation of duties and access controls applicable to the in-scope processes and systems;
- Tested a sample of cash collections for proper documentation of receipt, recording of the transaction, and reconciliations by the responsible employees; and
- Performed data analytics, where possible, on the population of transactions to identify trends.

The scope of this internal audit encompassed all FY2019 transactions for the DPRT operated SplashDown Waterpark, as well as, Tax Administration Division payments received by mail.

Fieldwork was performed October through February 2019.

**Note: Collection figures are based on unaudited reports generated from RecTrac, CashOne, and Ascend. Figures should not be considered official financial reporting.*

Summary of Observation Ratings

(See page 3 for risk rating definitions)

	High	Moderate	Low
Cash Handling	-	1	2

We would like to thank all County team members who assisted us throughout this audit.



EXECUTIVE SUMMARY – CONTINUED

Observations Summary

The following is a summary of the observations noted in the areas reviewed. Each detailed observation is included in the observations matrix section of the report. Definitions of the rating scale are included below.

Summary of Observations	
Observation	Rating
1. Tax Administration – Segregation of Duties	Moderate
2. Tax Administration – Cash Handling Procedures	Low
3. DPRT – Daily Cash Review, Approval, and Documentation	Low

Provided below is the observation risk rating definitions for the detailed observations.

Observation Risk Rating Definitions	
Rating	Explanation
Low	Observation presents a low risk (i.e., impact on financial statements, internal control environment, brand, or business operations) to the organization for the topic reviewed and/or is of low importance to business success/achievement of goals.
Moderate	Observation presents a moderate risk (i.e., impact on financial statements, internal control environment, brand, or business operations) to the organization for the topic reviewed and/or is of moderate importance to business success/achievement of goals. Action should be in the near term.
High	Observation presents a high risk (i.e., impact on financial statements, internal control environment, brand, or business operations) to the organization for the topic reviewed and/or is of high importance to business success/achievement of goals. Action should be taken immediately.



BACKGROUND

Overview

Prince William County collects, accounts for and manages public funds, such as cash and cash equivalents (checks, credit, etc.). The *Cash Handling and Cash Management Policy and Procedure* sets the standard across all departments/agencies that receive cash or cash equivalent payments. Employees who are assigned cash handling and cash management duties are required to complete training before performing their responsibilities.

Prince William County utilizes a bank-operated mail processing center (“LockBox”) to securely process payments received by mail and update corresponding customer accounts. Currently, Prince William County owns two lockboxes with Wells Fargo, one LockBox to process Tax Administration Division payments and one to process Emergency Medical Services (“EMS”) payments, separate due to HIPPA regulations. The LockBox is used to improve remittance processing speed (efficiency) and improve staff productivity by eliminating manual process steps.

The County recently transitioned bank services to Wells Fargo which enabled new bank services and functionality for departments/agencies to utilize. Major banking services and functions now available include: LockBox enabled online imaging capabilities, bill payer consolidations, among many minor functionality improvements. To facilitate applicable operations, the County utilizes Wells Fargo’s customer online portal, Commercial Electronic Office (CEO). Additionally, the County has contracted with Brinks for armored transport services at County collection points. Both DPRT and Tax Administration Division utilize Brinks for their deposit process.

The point of sales systems, RecTrac and CashOne, are used by DPRT and Tax Administration Division, respectively, to record transactions and perform daily reconciliations. Once cash and cash equivalent are received and recorded, safes or vaults are utilized to secure funds collected. The safes and vaults are secured by cameras, locks, and logs among other physical and logical access controls.

The financial management system, Ascend, is used by the County to record revenue collected for the day, adjust accounts receivable, reconcile bank statements, and store related financial data and support.

General Monitoring of Program

The entire cash handling and cash management process and policy is established, monitored, and updated by the County’s Finance Department. Overseen by the Director of Finance, the Finance Department’s role consists of enforcing compliance with the *Cash Handling and Cash Management Policy and Procedures*, authorizing the opening/closing of bank accounts, approving all department/agency requests for banking services, authorizing forms of payment accepted, and approving all County cash collection points.

Department Parks, Recreation, and Tourism (DPRT)

DPRT is responsible for ensuring its employees that are assigned cash handling and cash management responsibilities are adequately trained to perform their cash handling duties, as are all departments/agencies which collect cash and cash equivalents. It is the responsibility of the managers at the SplashDown Waterpark to review the PWC Cash Drawer Closing Balance Report for each register and compare them to the RecTrac Daily Transaction Report. After securing cash and checks within a safe, a different manager reconciles the cash and checks to the RecTrac Daily Transaction Report before sealing in a bag and signing the corresponding deposit ticket. The DPRT Fiscal Analyst collects the daily transaction totals from the DPRT team, and distributes an email to the Ascend E-mail Dropbox with a RecTrac file which includes collection totals for the day. The information is uploaded by the Finance Department’s Financial Systems Services Division into Ascend. Monthly, the DPRT Finance team performs a bank reconciliation between a Wells Fargo Revenue Report and a RecTrac Revenue Report to identify and correct any errors or discrepancies. Additionally, the DPRT Finance Manager or designee performs a monthly review of revenue and expense accounts to validate the chart of accounts are accurate. DPRT Managers throughout the year conduct random cashier audits by selecting a random cash drawer and verifying amounts by comparing the drawer to RecTrac and the PWC Cash Drawer Closing Balance Report for that day. All reservations for SplashDown Waterpark (rented facilities) are also captured within RecTrac. The DPRT Finance team also performs an annual audit of all DPRT cash collection sites



BACKGROUND – CONTINUED

General Monitoring of Program – continued

RecTrac does not interact directly with Ascend and cashiers only have access to conduct sales within RecTrac, onsite at approved cash collection points. Cashiers do not have access to manipulate data within RecTrac, but manager-level individuals have access to modify pricing when applicable. Voided transactions and a system activity log are maintained for review, as necessary.

Tax Administration Division

Tax Administration accepts payments over the counter and by mail at three sites: Sudley, Ferlazzo, and McCoart. At these sites, Clerks at the cashier desks receive mail from the mailroom and sort by description of payment. CountyOne is an integrated revenue management suite, composed of CashOne, RevenueOne and the Taxpayer Portal. All payment information is processed through CashOne before being sent to a Tax Administration Supervisor for approval. CashOne is used primarily as the point-of-sale system to record payments, while RevenueOne is the tax receivable system used to manage customer (citizen) accounts. Information submitted through CashOne automatically flows into RevenueOne to update customer accounts. At the end of each day, all registers are locked and cash and checks are placed in the applicable deposit bag and secured in the safe. The following morning deposits are prepared and entered into the Ascend accounts receivable module by Revenue Accounting before Brinks arrives to retrieve the bags and deposit slips and perform their secured transport to the bank. Multiple security cameras are utilized within the cash collection area and the video footage is stored for 90 days. The Finance Department's Financial Reporting and Control (FRC) Division performs a monthly reconciliation between the bank and Ascend.

Clerks do not have access to manipulate CashOne data. RevenueOne stores customer account information and is updated automatically based on transactions processed within CashOne. Access to RevenueOne and CashOne are tied to the County's network protocols, and permissions are granted based on job duties. RevenueOne users must have an active County network ID to access the system. County network passwords are reset every 90 days. Additionally, users must have a profile within RevenueOne that restricts or permits their activities and staff within the Financial Systems Division must have granted them access to the application as well as properly configured each users (.Net) framework.



FINANCIAL ANALYSIS

DPRT Collections

DPRT utilizes eighteen (18) collection points for various operational activities. These designated collection points must be authorized every three (3) years by the County's Finance Department. The active DPRT collection points include historical properties, waterpark, fitness centers, pools, among others.

The following chart represents the cash and cash equivalents, collected through DPRT collection points, over the past five fiscal years:

DPRT FY15 – FY2019 Collections for Services	
Fiscal Year	Total Collections
2015	\$ 9,932,460
2016	\$ 10,155,660
2017	\$ 10,348,122
2018	\$ 9,897,875
2019	\$ 9,847,703

DPRT Collection Points

The chart below represents the top five (5) DPRT cash collection points, in terms of cash and cash equivalents from July 1, 2014 through June 30, 2019.

Top 5 DPRT Collection Points – Fiscal Years 2015 - 2018					
Collection Point	FY15	FY16	FY17	FY18	Grand Total
Chinn Aquatics & Fitness Center	\$2,038,663	\$2,065,021	\$2,069,945	\$2,107,731	\$10,150,516
Hellwig Park	2,187,470	1,755,257	1,921,740	1,695,821	9,246,695
SplashDown Waterpark	1,932,481	1,851,049	1,629,412	1,495,970	8,679,995
Sharron Baucom Dale City Rec Center	1,657,801	1,510,028	1,180,340	1,138,976	6,837,512
Web*	-	498,177	1,271,857	1,397,624	4,150,773
Grand Total	\$10,321,526	\$10,048,012	\$10,127,190	\$9,896,432	\$50,181,822

*Web accounts for online collection are provided across different collection points.

The method of payment customers utilized to purchase DPRT goods and services have changed over the past five (5) fiscal years. Credit and debit card payments have increased 7% while cash and checks have decreased by 7%



FINANCIAL ANALYSIS – CONTINUED

DPRT SplashDown Waterpark

During FY2019, SplashDown Waterpark generated \$1.6 million in cash and cash equivalents. The graphs below depict monthly collections in terms of dollars (\$) received during FY2019 and SplashDown Waterpark's total collections over the past 5 fiscal years (FY2015 – FY2019).

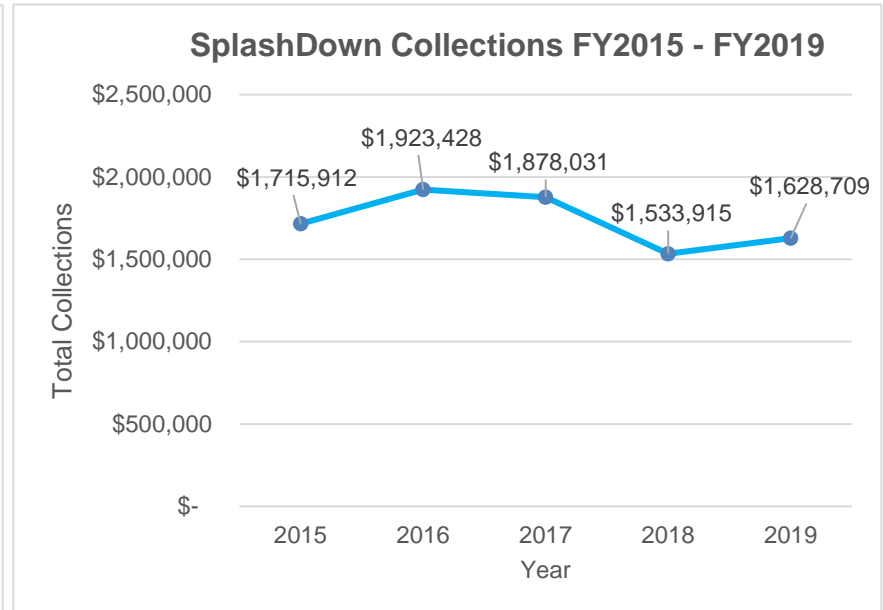
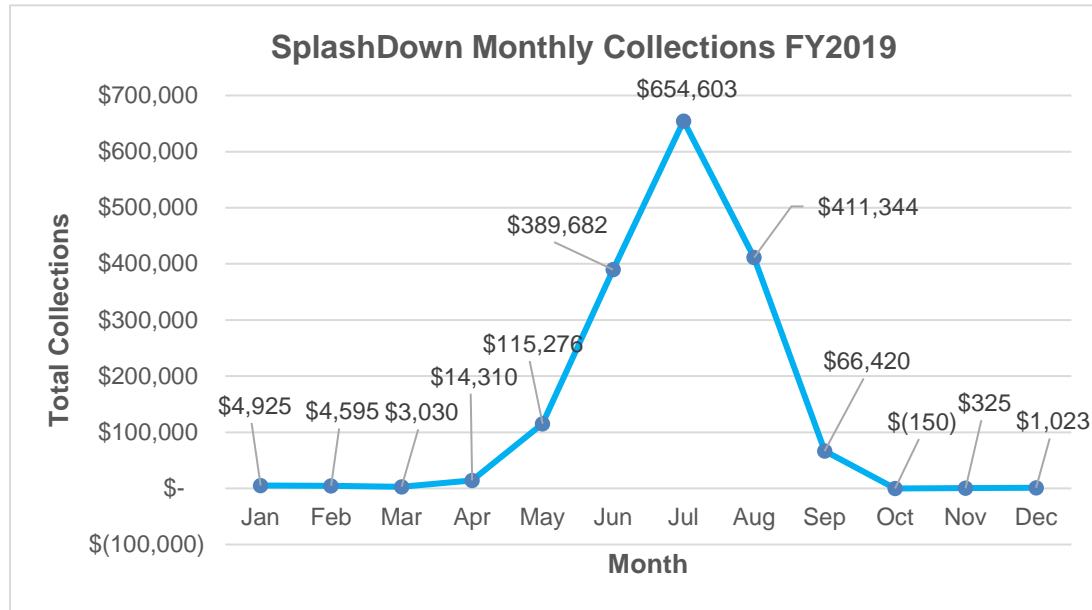

Note: SplashDown Waterpark is open between Memorial Day and Labor Day

SplashDown Waterpark generates cash and cash equivalents from a variety of different goods and services categories. The chart below depicts the top five (5) collection categories which represent ~94% of FY2019 cash and cash equivalents.

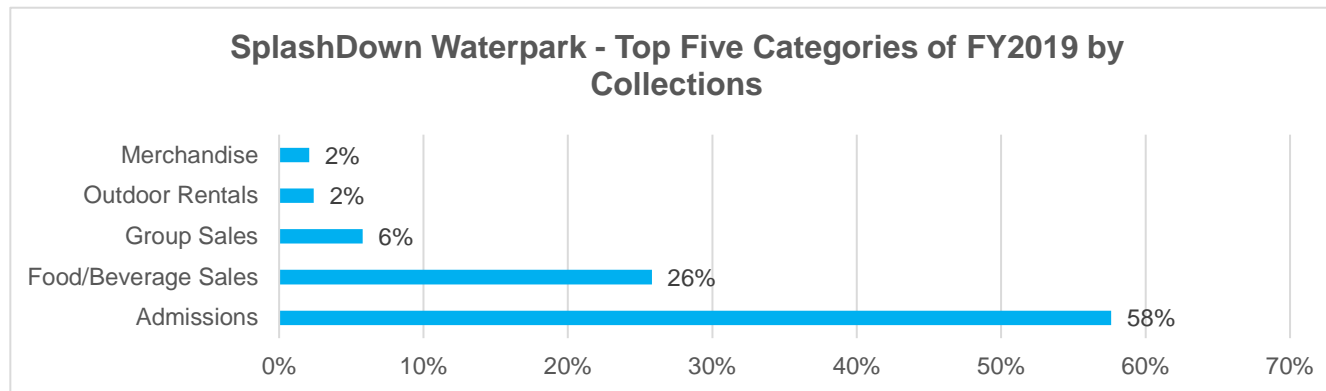



FINANCIAL ANALYSIS – CONTINUED

Tax Administration Division

Taxes are collected for a variety of purposes, but real estate and personal property taxes account for the majority of all taxes collected (~91% during FY2019).

Tax Category	FY2019 Payments
Real Estate	79%
Personal Property	12%
Business Tangible Property	5%
Business License	3%
Transient Occupancy	1%
Bank Franchise	<1%
Daily Rental	<1%
Dog License	<1%
Public Service Corporation	<1%

Payment Method by Tax Category										
Payment Method	Bank Franchise	Business License	Business Tangible Property	Daily Rental	Dog License	Personal Property	Public Service Corporation	Real Estate	Transient Occupancy	Total % of Tax Payment Methods
Counter	100%	29%	13%	6%	16%	15%	8%	5%	7%	11%
Debt Set-off Payment	0%	<1%	0%	0%	0%	3%	0%	<1%	0%	2%
Fund Transfer	0%	<1%	<1%	0%	0%	<1%	25%	<1%	0%	<1%
Lockbox	0%	0%	56%	0%	<1%	22%	25%	14%	0%	18%
Mail	0%	51%	11%	66%	60%	10%	42%	4%	70%	9%
Mortgage Service Co. Payment	0%	<1%	<1%	0%	<1%	<1%	0%	71%	0%	31%
Official Payments	0%	4%	4%	0%	5%	21%	0%	1%	2%	11%
Online Bank Check	0%	1%	1%	0%	<1%	1%	0%	1%	0%	1%
Online E-Check	0%	15%	14%	28%	18%	28%	0%	5%	21%	17%



FINANCIAL ANALYSIS – CONTINUED

Tax Administration Division – continued

During FY2019, the Tax Administration Division received over 29% of payments by mail. ~20% of mail payments were received and processed at the County's LockBox while ~9% were received and processed at one of the three collection points. The graph below illustrates the breakdown of mail payments received and processed at collection points vs. the LockBox for various tax categories.

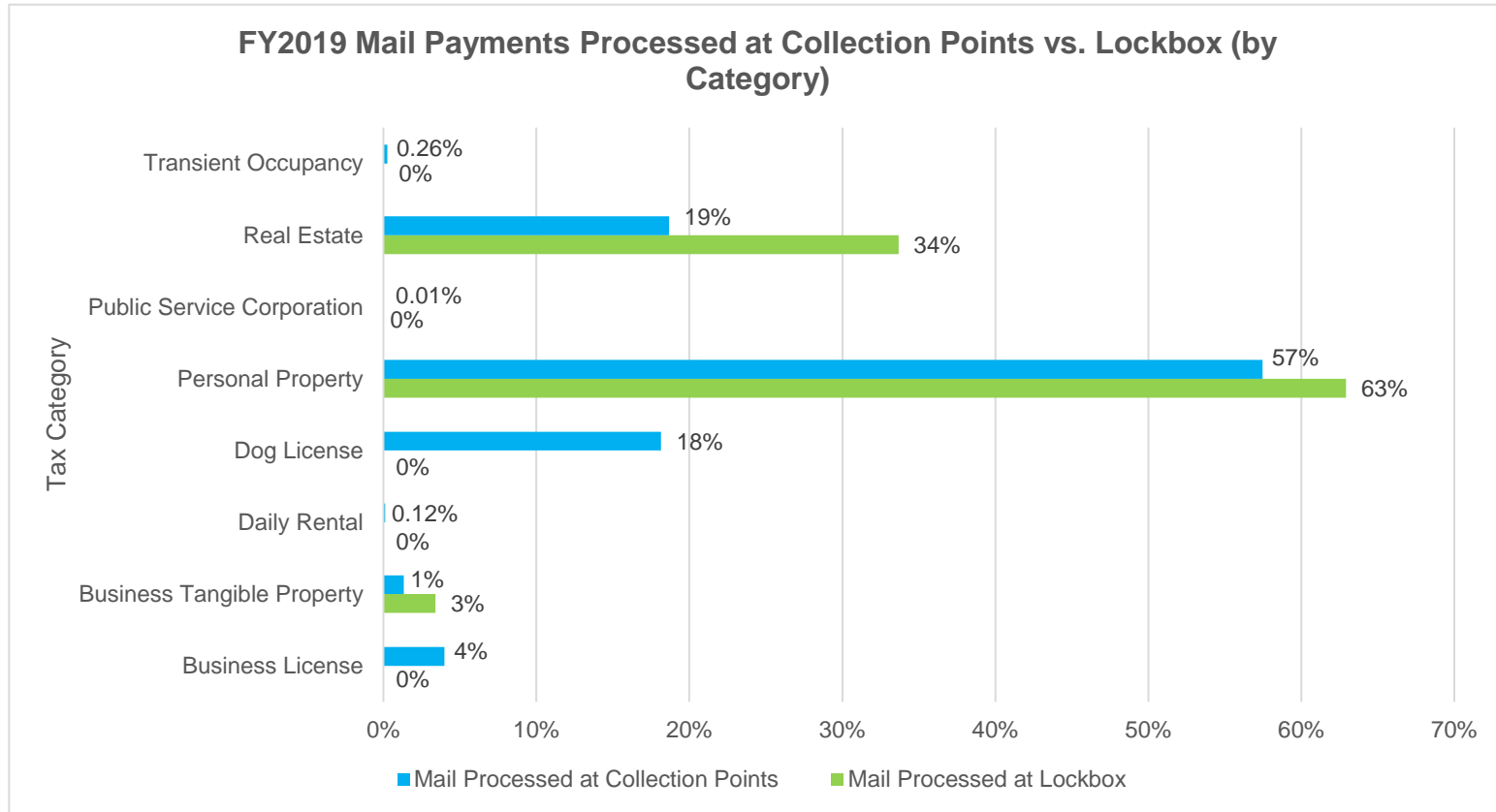



FINANCIAL ANALYSIS – CONTINUED

Tax Administration Division – continued

During FY2019, ~9% of all payments were received by mail and processed at a collection point, excluding the LockBox facility. The graph below illustrates the average processing speed of mail payments at collection points during FY2019 by month. Users are instructed to mail payments to the LockBox, but various reasons may require Clerks at applicable collection points to process the payment instead. All mail not able to be processed by the LockBox is distributed to the primary collection point for manual processing. Prior to distributing the mail to the collection point, LockBox failures are uploaded to the Wells Fargo customer online portal, Commercial Electronic Office (CEO), daily for Tax Administration Division review for proactive issue resolution. If a failure uploaded to the CEO can be addressed by the Tax Administration Division, the Lockbox will process the payment as originally intended. All payments received at the LockBox facility are processed same day or distributed to the primary collection point. The Lockbox currently only processes payments for personal and real estate tax categories.

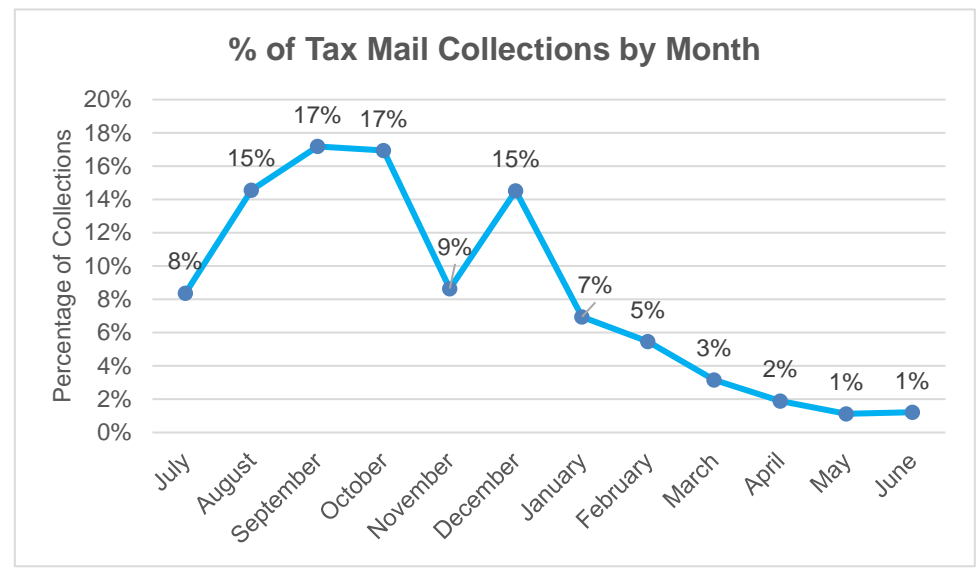
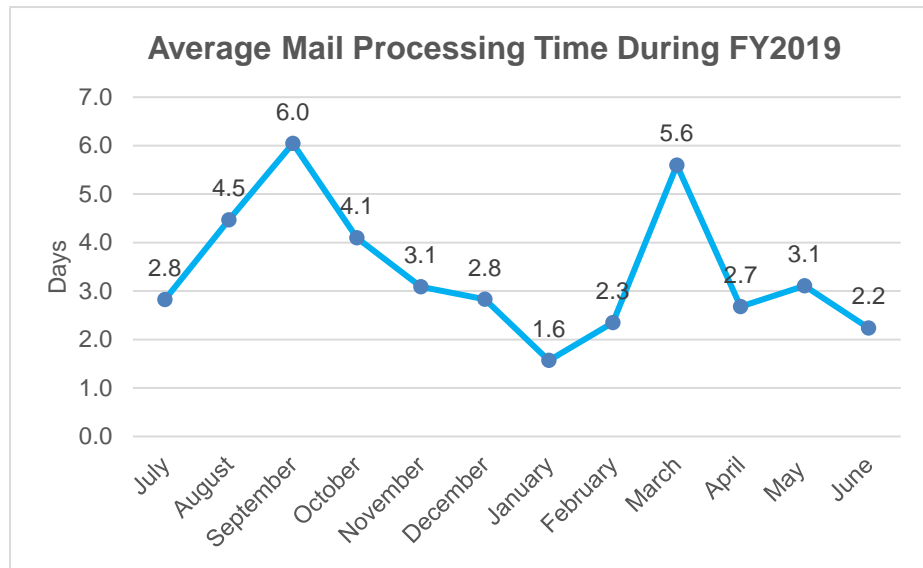

Utilizing collection data from FY2018 we were able to determine the Tax Administration Division collection points processed mail ~20% faster during FY2019. Additionally, it was noted, that ~12% less mail payments were processed at collection points during FY2019 (not including LockBox). Between FY2018 and FY2019 payments received by online e-check increased by 10% to ~110,000 and payments received at the County’s LockBox increased 2% to ~115,000. The Tax Administration Division is supporting increased efforts to accept payment via electronic or automated mediums.



OBJECTIVES AND APPROACH

Objectives

The primary objective of this internal audit was to evaluate the effectiveness and adequacy of key processes and control functions for cash handling within a specific department(s) and assess compliance with applicable County policies and procedures. The scope of this internal audit encompassed all FY2019 transactions for the DPRT operated SplashDown Waterpark, as well as, Tax Administration Division payments received by mail.

Approach

Our audit approach consisted of the following three phases:

Understanding and Documentation of the Process

During this phase of the audit, we conducted interviews with the appropriate representatives from the Finance Department, DPRT Finance Team and Tax Administration Division to discuss the scope and objectives of the audit work, obtain preliminary data, and establish working arrangements. We obtained and reviewed 1) copies of financial information; 2) applicable County policies related to this internal audit and 3) other documents deemed necessary, performed walkthroughs of the process(es) and key controls to gain an understanding of the function and assess the design of the process/key controls, documented the process(es) via flowchart, and developed a risk-based work plan for the evaluation of the design and operating effectiveness of processes and controls, based on the information obtained through our review, inquiry and walkthrough procedures.

Evaluation of the Process and Controls Design and Testing of Operating Effectiveness

The purpose of this phase was to test for compliance and operating effectiveness of the process and key controls on a sample basis. Our testing was conducted utilizing sampling and other auditing techniques to meet our audit objectives outlined above. Procedures included the following:

- Identified and assessed the effectiveness of segregation of duties and access controls applicable to the in-scope processes and systems;
- Assessed the adequacy of applicable policies, procedures and guidelines;
- Assessed the adequacy of document retention procedures related to cash handling and cash management;
- Tested a sample of customer transactions at one DPRT collection point to validate cash handling procedures were appropriately followed, including verification of the following:
 - Funds were receipted at time of initial collection in a manner authorized by County policy;
 - Proper segregation of duties;
 - Applicable register discrepancies were investigated, documented, and certified with reason for shortage/overage and manager/supervisor signature;
 - RecTrac report reconciled to deposit slip and finance Ascend report;
 - Cash deposits are properly documented within evidence of appropriate approvals;
 - Cash drawer opening balances are verified for accuracy by an employee prior to beginning daily operations;
 - No evidence of improper cash handling such as; issuing a refund from funds collected without verifying original transaction, acceptance of post-dated checks, acceptance of checks for an amount over what was owed, etc.;
 - Funds collected were posted to the correct GL account;
 - Funds collected were posted timely in accordance with County policy (posted for the proper fiscal month prior to month-end closing date);
 - Funds were deposited within 3 business days of receipt;
 - Monthly revenue reconciliations were performed by the DPRT Finance Team; and
 - Change fund requests are approved by applicable managers via signature on Cash Drawer Open Balance Report;
- Tested a sample of check payments received by mail at Tax Administration collection points to validate certain cash handling procedures were appropriately followed, including verification of the following:
 - Funds were receipted at time of initial collection in a manner authorized by County policy;
 - Proper segregation of duties;



OBJECTIVES AND APPROACH – CONTINUED

Approach – continued

- Applicable register discrepancies were investigated, documented, and certified with reason for shortage/overage and manager/supervisor signature;
- Cash One deposit summary reconciles to deposit ticket total and bank summary;
- Transferred cash is maintained and documented including date, time, signature of the individuals involved, and amount handed over;
- Cash drawer opening balances were verified before operation commence;
- Funds collected were posted to the correct GL account;
- Funds collected were posted timely in accordance with County policy (posted for the proper fiscal month prior to month-end closing date);
- Funds were deposited within 3 business days of receipt; and
- Monthly revenue reconciliations were performed;
- Assessed Tax Administration performance related to processing of checks received by mail;
- Reviewed forms utilized; and
- Performed data analytics, where possible, on the population of transactions to identify trends.

Reporting

At the conclusion of this audit, we summarized our findings into this report. We conducted an exit meeting with the appropriate Management personnel and have incorporated Management's response into this report.



OBSERVATIONS MATRIX

Observation	1. Tax Administration Division – Segregation of Duties
<p>Moderate</p>	<p>The County's <i>Cash Handling and Cash Management Policy and Procedures</i>, section 300.1, states "Segregation of duties related to cash handling and cash management should separate the duties of authority, recordkeeping, custody, and reconciliation...If a department/agency is not able to meet this requirement, due to staffing or budgetary constraints, a mitigating control(s) must be documented within their detailed, written internal standard operating procedures."</p> <p>It is a long-standing best practice to have more than one individual be responsible for initiating, approving, recording, and reconciling transactions. While our scope related to Tax Administration was limited to checks received by mail, we gained a preliminary understanding of front-end cash handling procedures.</p> <p>Based on fieldwork performed, we identified the following segregation of duties conflicts that appear to violate the County's <i>Cash Handling and Cash Management Policy and Procedures</i>:</p> <p><i>Note: The information included below does not depict the entire process related to Tax Administration's handling of revenue or cash and cash equivalents. It is a summary focused on segregation of duties as they relate to County-wide Cash Handling and Cash Management Policy and Procedures and the scope of this audit.</i></p> <ul style="list-style-type: none"> • Based on the evidence retained and provided by Tax Administration for a sample of collections at one Tax Administration cash collection point, the same individual is performing reviews of cashier collections, preparing deposits, and recording daily collection activity into Ascend. Tax Administration Division Clerks (Accounting Assistant II) collect cash and cash equivalents throughout the day and perform closing operations for their assigned register, including a physical count of cash and checks collected. The Clerks' counts, by denomination, are recorded electronically within CashOne. A reviewer (Fiscal Specialist in Revenue Accounting) performs a review of the cash and checks collected against a CashOne report of daily activity. After validating funds are correct, a deposit slip is prepared. All revenue is recorded daily into an Ascend AR clearing account (tax bucket) by the same reviewer. Monthly, a General Ledger ("GL") interface file is taken from the RevenueOne system and a journal entry is prepared by the Fiscal Specialist in Revenue Accounting and reviewed and posted by Financial Reporting and Control Accounting ("FRC"). This journal entry distributes the income out of the clearing account to all respective Tax Administration accounts according to the GL accounts in Revenue One. <ul style="list-style-type: none"> ○ There are certain compensating controls in place to limit risk, including: the reviewer cannot adjust a Clerk's count recorded in CashOne and variances would result in overage/shortages which are reported for correction. All journal entries posted to the GL are reviewed and approved within Ascend prior to posting by an individual within FRC. • Based on the evidence retained and provided by Tax Administration for a sample of collections at one Tax Administration cash collection point, a manager performs as cashier, reviewer, and depositor. <ul style="list-style-type: none"> ○ There are certain compensating controls in place to limit risk, including: all voided transactions are reviewed by a separate individual and journal entries are prepared by a separate individual. <p>Revenue forecasting is performed annually for each tax category based on amounts owed by citizens. Large variances between forecasted and actual would be flagged and investigated. Additionally, customers receive receipts and credits to their tax accounts after a payment is processed, therefore a scheme to intentionally misappropriate funds would require manipulation of customer accounts in a way that would not be detectable as part of the daily cash/deposit reconciliation process.</p> <p>Without proper segregation of duties, including compensating controls, there is an increased opportunity and likelihood of manipulation of system data, transactions, and the compromising of data leading to the misappropriation of assets, errors, or other types of irregularities to occur without being detected in a timely manner, if at all.</p>



OBSERVATIONS MATRIX – CONTINUED

Observation	1. Tax Administration Division – Segregation of Duties – continued
Recommendation	<p>We recommend that duties be appropriately segregated. If additional resources are not available to enable complete segregation of duties, compensating controls should be identified and documented, as required, within cash handling procedures. For example: additional reviews by someone independent of the activities, should be performed to validate the accuracy of cash handling processes performed. For instance, for illustrative purposes only, reports could be generated summing changes in tax accounts within RevenueOne which could enable a comparison to cash and cash equivalents collected. Mitigating controls should be documented and approved by the County's Finance Department when they are utilized to supplant required segregation of duties.</p> <p>Based on our understanding, various teams and individuals are responsible for a myriad of tax types which do not all follow the same collection process. Coupled with recent managerial changes and the fact that the Division is responsible for the majority of the County's revenue; we are recommending an Internal Audit be completed of the entire cash handling process related to all tax types due to the Division's inherent high-risk.</p>
Management Action Plan	<p>Response: Currently, the following controls are being implemented to ensure adequate segregation of duties: The reviewer (Fiscal Specialist in Revenue Accounting) will still perform the review of the cash and checks collected against a CashOne report of daily activity and prepare the bank deposit. However, the revenue will be recorded daily into an Ascend AR clearing account (tax bucket) by a different employee. In addition, user profiles in RevenueOne and CashOne are being reviewed and updated to ensure segregation of duties; beginning May 15, all payments (OTC, mail, departmental, and electronic) will be processed by front counter personnel only; two staff members from Revenue Accounting will be reassigned to the front counter to review the daily collections and do the bank deposit. The revenue reconciliation and posting to Ascend functions will still be performed by Revenue Accounting.</p> <p>Revenue Accounting personnel will perform all revenue reconciliations and posting to Ascend. It is imperative that the currently vacant Revenue Accounting Supervisor position is filled as soon as possible because without it, it would be challenging implementing and monitoring adequate internal controls. Without a supervisor in this area, the functions would need to be assumed by other already overwhelmed supervisors who would also be monitoring their own areas.</p> <p>Responsible Party: Assistant Director of Finance for Taxpayer Services</p> <p>Estimated Completion Date: Six months after Revenue Accounting is fully staffed.</p>



OBSERVATIONS MATRIX – CONTINUED

Observation	2. Tax Administration Division – Cash Handling Procedures
Low	<p>We noted the following discrepancies between Tax Administration Division processes and the County's <i>Cash Handling and Cash Management Policy and Procedures</i>:</p> <ul style="list-style-type: none"> • <i>Cash Handling and Cash Management Policy and Procedures, Section 100.5 "Responsibility"</i>, states that Tax Administration Division will "Develop and maintain detailed, written internal standard operating procedures for the verification and posting of all deposits received and recorded into the Ascend financial management system and the RevenueOne tax administration system;" <ul style="list-style-type: none"> ○ Tax Administration Division has no documented standard operating procedures in place to provide guidance on the day-to-day tasks related to cash handling roles, responsibilities, processes, and controls. The Division maintains an employee policy which provides various guidance and requirements but does not capture the specific steps related to the completion of daily processes. • <i>Cash Handling and Cash Management Policy and Procedures, section 300.2 "Cash Drawers"</i>, states, "Cash drawer opening balances must be verified by a count and the amount recorded along with the signature and date of the employee counting the drawer before operation commences." <ul style="list-style-type: none"> ○ Review of cash drawer opening balances with corresponding signature and date of the performing employee are not currently documented before daily operations commence. However, the cashiers will count their change fund at the end of the day to separate the change fund—\$100—from the cash collected and the same register is utilized the following day. At the beginning of the day, the cashier will complete a one-click response within CashOne to verify they're starting with \$100 to begin the day. A daily "deposit summary" report shows the starting cash balances for each register and weekly audits are being performed by a separate cashier to verify the count of the funds is \$100. We did not identify discrepancies in daily cash balances as part of our transactional testing. • <i>Cash Handling and Cash Management Policy and Procedures, section 300.1</i>, states "Segregation of duties related to cash handling and cash management should separate the duties of authority, recordkeeping, custody, and reconciliation...If a department/agency is not able to meet this requirement, due to staffing or budgetary constraints, a mitigating control(s) must be documented within their detailed, written internal standard operating procedures." <ul style="list-style-type: none"> ○ The Tax Administration Division does not have documented mitigating controls, for instances in which segregation of duty requirements are not met, as required by County policy. <p>Specific cash handling requirements and processes vary department-to-department. Documented procedures help reduce the risk of errors or misappropriations, and increase consistency in cash collection and handling processes. Clear written procedures also serve as a training tool for new staff and encourage consistent processes in the event of employee turnover or other interruption of normal.</p>
Recommendation	<p>We recommend the Tax Administration Division document their current practice(s) for cash collection and handling in formal written procedures as required by the County's <i>Cash Handling and Cash Management Policy and Procedures, Section 100.5</i>. Procedures should include areas such as: roles and responsibilities, definitions, applicable processes, account management, monitoring and managing internal controls, and enforcement. These policies and procedures should be reviewed and updated (if necessary) on, at least, an annual basis.</p>



OBSERVATIONS MATRIX – CONTINUED

Observation	2. Tax Administration Division – Cash Handling Procedures – continued
Management Action Plan	<p>Response: Concur, The Finance Department Taxpayer Services Division has been challenged with inadequate staffing. Since this internal audit was initiated, a new Assistant Director of Finance for Taxpayer Services has been hired. The Assistant Director has been focused on evaluating the controls in place within Taxpayer Services and facilitating the documentation of standard operating procedures. Since December 2019, the Assistant Director has implemented the following controls and standard operating procedures:</p> <ul style="list-style-type: none">• SOPS and policies are under development• Cashier Opening and Daily Audit Procedures have been implemented to address item #2 <p>Responsible Party: Assistant Director of Finance for Taxpayer Services</p> <p>Estimated Completion Date: December 2020</p>



OBSERVATIONS MATRIX – CONTINUED

Observation	3. DPRT – SplashDown Waterpark Daily Cash Review, Approval, and Documentation
Low	<p>As part of SplashDown Waterpark’s cash handling procedures, a two-level review is completed daily for all cash drawers prior to closing. This includes (1) cashier utilizing a specific drawer for each day of operation, and (2) a separate employee, usually a head cashier or manager, verifying the cash and check counts, by denomination, before placing the funds within the designated safe.</p> <p>DPRT’s <i>Revenue and Cash Handling Policy, section 4</i>, includes the following requirements:</p> <ul style="list-style-type: none"> • “Cashiers must verify cash drawer fund amounts when opening a new drawer or closing a drawer. Cashiers are responsible for the integrity and protection of the cash in the register drawer. • Staff members responsible for balancing the daily revenue must have another staff member witness their closing drawer count by validating total funds prior to close out of their shift.” <p>We identified the following as part of our transactional testing of cash handling procedures at SplashDown Water Park:</p> <ul style="list-style-type: none"> • One (1) instance in which the cashier didn’t sign-off on the Cash Drawer Opening Balance Report; and • One (1) instance in which no evidence of reviewer approval was captured on the Cash Drawer Closing Balance Report. • Eighteen (18) of twenty (20) samples, that included a Cash Drawer Closing Balance Report, included the cashiers count of each bill type (\$1, \$2, \$5, \$10, \$20, \$50, \$100), but were missing the reviewers count of each bill type. Evidence of the reviewer’s bill count was limited to their signature. • Nine (9) instances in which there was no evidence that the cashier returned their cashiers key on the Cash Drawer Closing Balance Report. <p>Failure to complete funds handling controls, may lead to errors, inconsistencies, and misappropriation of funds.</p>
Recommendation	<p>We recommend a re-emphasis be provided to all SplashDown Waterpark employees of the required review process to substantiate funds collected. The re-emphasis can be accomplished by distributing the results of this internal audit, including updated policies and procedures for all employees working at SplashDown Waterpark before opening day.</p>
Management Action Plan	<p>Response: Management concurs with the observation. Since reviewing this observation with the auditors, DPRT-Finance held an end of season meeting with the managers of our recreation cash collection sites (including Splashdown) to review any cash handling issues/concerns that were observed during the prior season. During this meeting we informed the managers of this observation and re-emphasized the importance of the required review process and asked that they relay the importance of the process to the cash handlers at their site.</p> <p>DPRT-Finance will increase the number of samples that are pulled for the next Splashdown internal audit (FY21-22 Season) to test for adherence to the DPRT Revenue & Cash Handling Policy. We have also created and distributed additional training tools (videos) to allow for sites to have on-demand training as a refresher throughout the year.</p> <p>Responsible Party: DPRT-Finance</p> <p>Estimated Completion Date: Completed and ongoing</p>



PROCESS IMPROVEMENT OPPORTUNITIES

1. Dog Licensing

All dogs four months of age or older must be licensed by the end of the day on January 31st each year, or within 30 days of being located by their owners in Prince William County. Dog licenses are renewed annually; beginning November of each year. The fee for a dog license is \$10.00 and the collection and processing is completed by the Tax Administration Division, similar to collections for tax payments. During FY2019, dog licensing generated total collections of \$228,334 from 16,949 payments processed through the County.

While new and renewal dog license payments are accepted online, there are opportunities to streamline this process through the use of automation. For each new dog license, applicable forms are completed by citizens and the information, along with payments, are collected and utilized by staff to create records within RevenueOne. The current process is largely reliant on manual data entry by County staff to facilitate the process. Currently, the Assistant Director of Finance for Taxpayer Services estimates a team of 12 FTEs—in addition to primary job responsibilities—are responsible for the dog license program including printing dog license letters, sending assigned tags, validating rabies certificates, and updating accounts.

The County should explore opportunities to outsource and/or automate the dog licensing process to optimize County resources to focus on the core competencies of the Tax Administration Division. By outsourcing and/or automating, the County could gain efficiencies for the dog licensing process, but also other operations within Tax Administration since additional staff bandwidth would become available (see 2015 Cash Handling and Process Internal Audit Report for staffing ratios compared to peers).

2. Image Cash Letter

The Tax Administration Division does not utilize image cash letter technology (a.k.a. remote deposit capture) for checks collected through mail or in-person (excluding LockBox). Instead checks are scanned and retained within CashOne and then follow the standard cash handling procedures to be deposited similar to cash. Therefore, although each check is scanned it must still be manually deposited.

The County should explore opportunities with their banking service provider (Wells Fargo) to utilize image cash letter technology at cash collection points to reduce duplicative and manual processes. Benefits of image cash letter utilization may include: decrease fraud, quicker collections, increased transaction accuracy, and less physical deposits.



PROCESS MAP(S)

Note: Process Maps related to the Tax Administration Division were not developed due to our limited scope within the function. Process maps will be developed as part of the recommended Internal Audit of the Tax Administration Division's cash handling processes related to all tax types and collection methods.

Prince William County – Splashdown Cash Handling and Cash Management Process

Page 1 of 4

Opening/Reconciliation

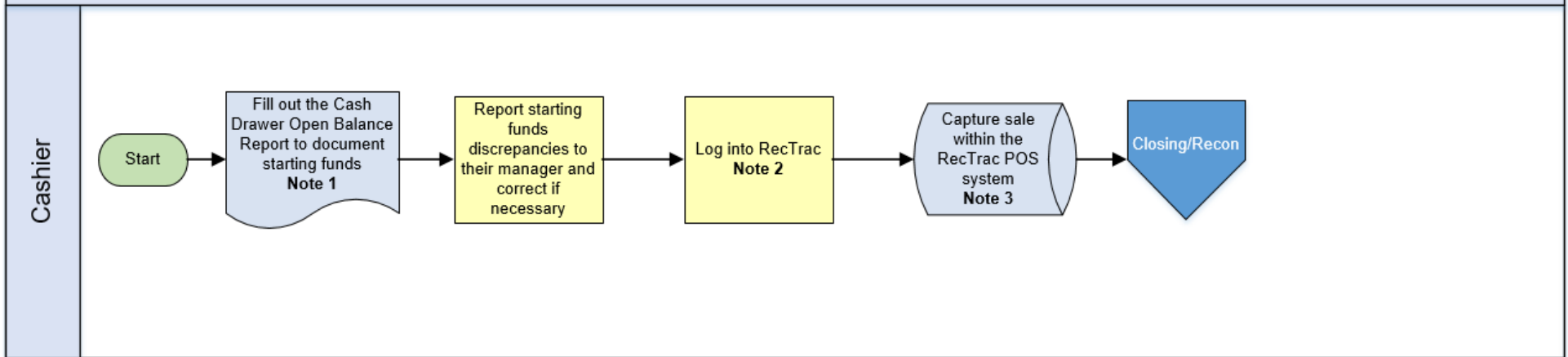

- Notes:
1. Change funds are equally disbursed totaling \$147.50 per reach opened register
 2. Employees must go through cash handling training before getting an ID with access to RecTrac
 3. RecTrac is a fully integrated parks and recreation management point of sales software

Legend:

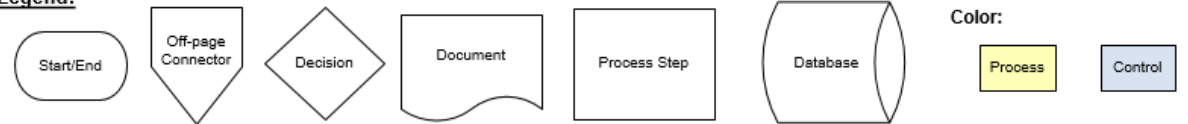



PROCESS MAP(S) – CONTINUED

Prince William County – Splashdown Cash Handling and Cash Management Process

Opening/Reconciliation

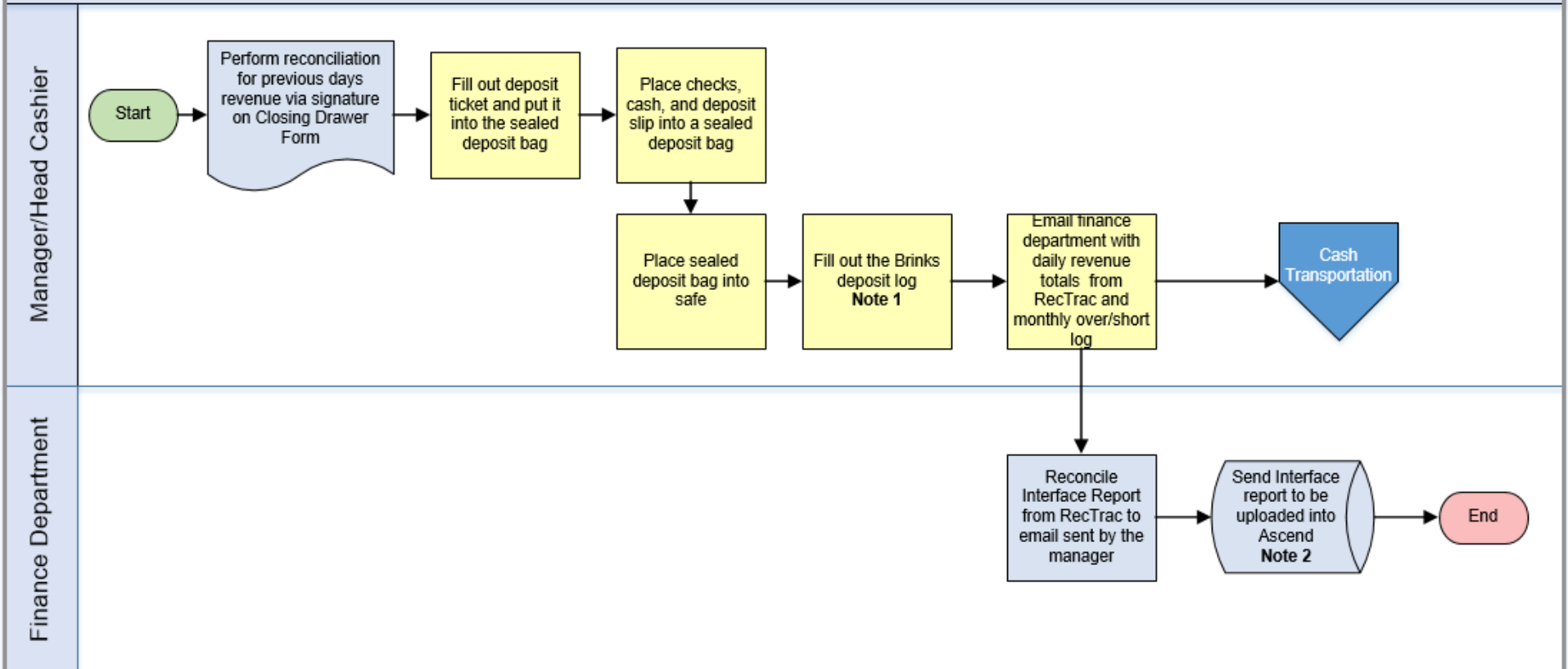

Notes:
 1. Ascend is Prince William County's ERP System
 2. Brinks is a private security and protection company served to transport cash and cash equivalents to Prince William County's bank account

Legend:

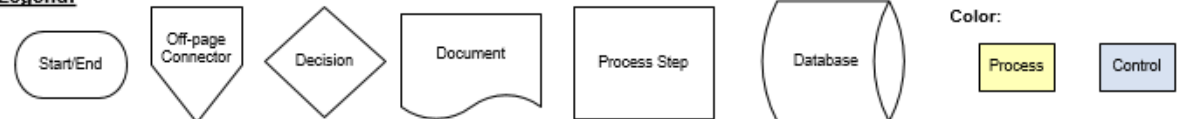



PROCESS MAP(S) – CONTINUED

Prince William County – Splashdown Cash Handling and Cash Management Process

Cash Transportation

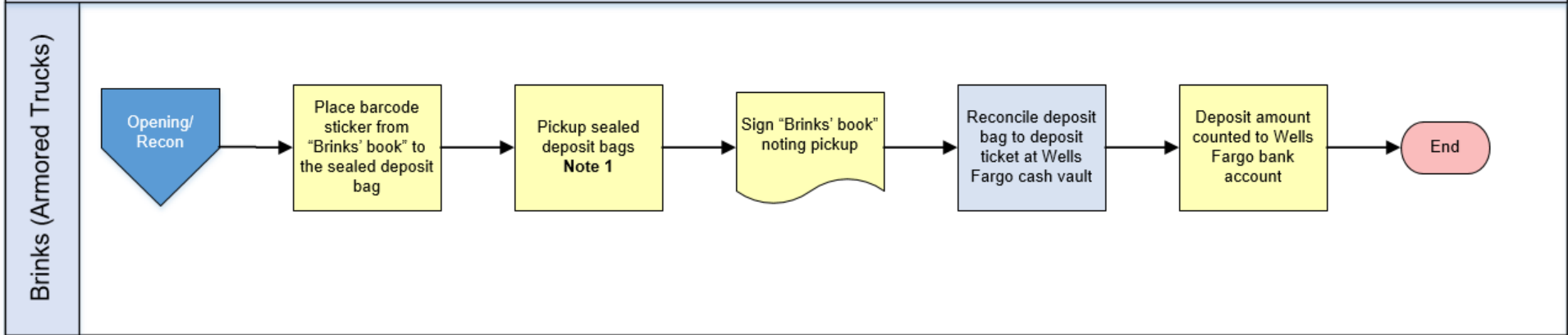

Notes:
 1. Within county policy, deposits must be ready to transport within 3 business days to the bank.

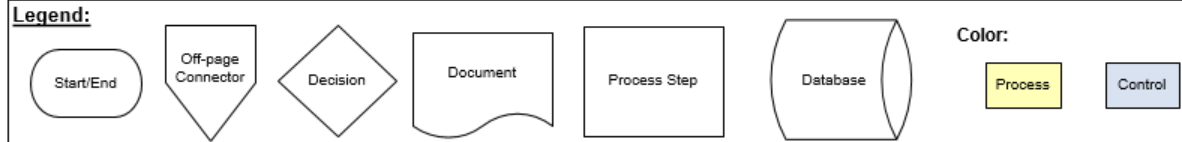



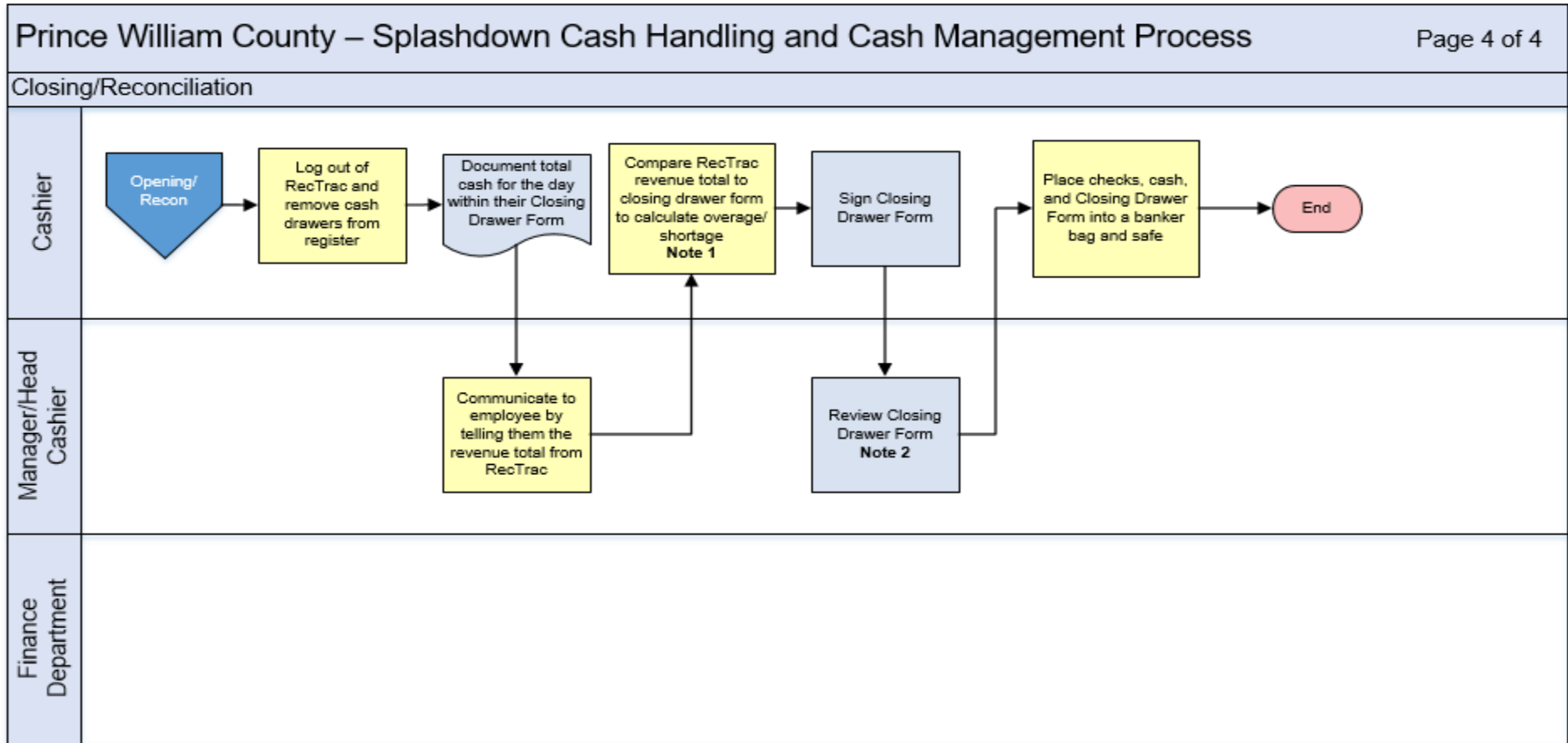

PROCESS MAP(S) – CONTINUED

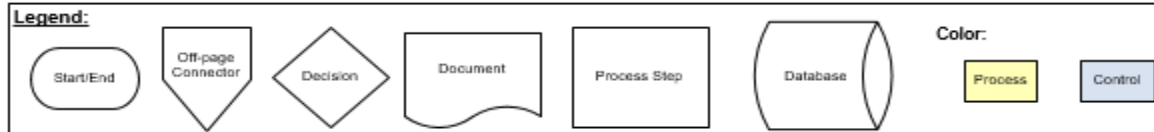

Notes:
 1. Overages or shortages in excess of \$5 must be maintained in their Closing Drawer Form and an explanation is sent to the Finance Department
 2. Revenue must be completed and sent to Finance Department within 2 business days.





RSM US LLP
1861 International Drive
Suite 400
McLean, VA 22102
321.751.6200

www.rsmus.com

RSM US LLP is a limited liability partnership and the U.S. member firm of RSM International, a global network of independent audit, tax and consulting firms. The member firms of RSM International collaborate to provide services to global clients, but are separate and distinct legal entities that cannot obligate each other. Each member firm is responsible only for its own acts and omissions, and not those of any other party.

For more information, visit rsmus.com/aboutus for more information regarding RSM US LLP and RSM International.

© 2020 RSM US LLP. All Rights Reserved.

